

Smallest in the industry!

MICRO CYLINDER

With a surprisingly compact width of just 10 mm, it supports the full electrification of equipment.



IAI
Quality and Innovation

Rod type
Coupled motor type

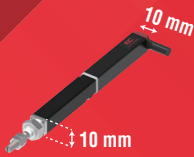

Rod type
Side-mounted motor type

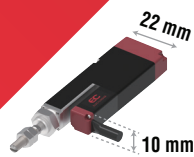
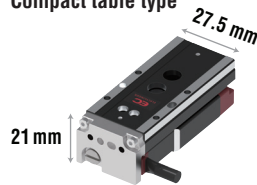
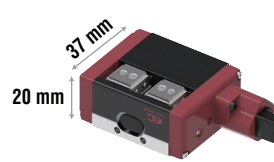

Table type
Compact table type



Gripper
Flat type



Gripper
Vertical type



Product width 1cm x 1cm

Despite its small size, it features a built-in encoder, providing a repeatability of ± 0.02 mm.

All in one!

- ✓ Ball screw
- ✓ Motor
- ✓ Encoder

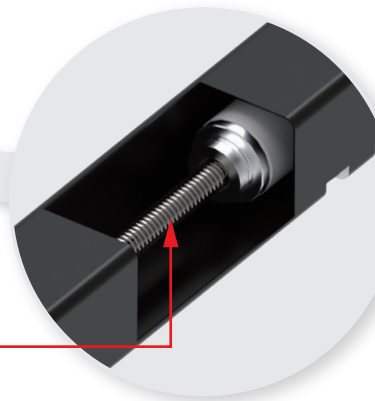

$\varnothing 2.5$

Equipped with a $\varnothing 2.5$ rolled ball screw, it achieves both **compact size** and **high payload**.



Previous model: EC-T3

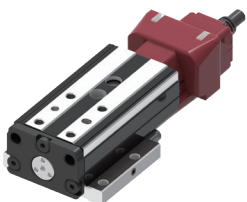

Stroke	10 to 50 mm
Max. payload	Horizontal: 2 kg Vertical: 0.8 kg
Max. speed	200 mm/s
Max. push force	17 N

Max. payload
(vertical)

**Approx.
2 times**

Micro Cylinder: EC-T2

NEW



Stroke	20 to 50 mm
Max. payload	Horizontal: 3.5 kg Vertical: 1.5 kg
Max. speed	97 mm/s
Max. push force	25 N

In-line controller

This controller is equipped with the built-in cable. Since the cable can be installed inside the customer's machine, it allows for a more compact control panel.



It helps save space!

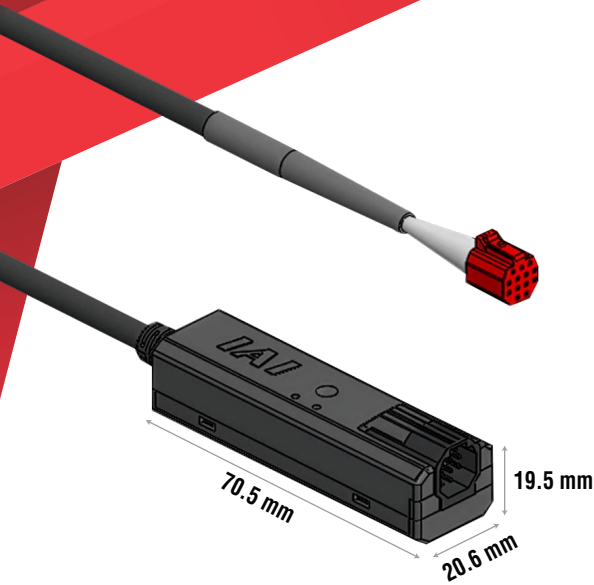

Installation example

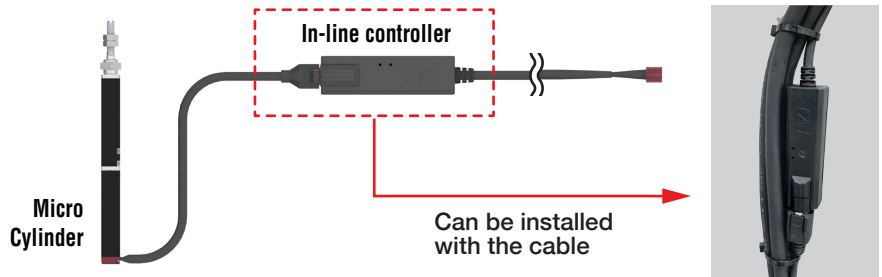

Application examples

Gear assembly device using small EC/RC products

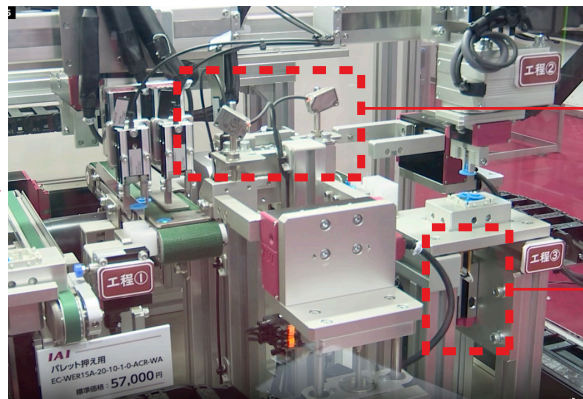
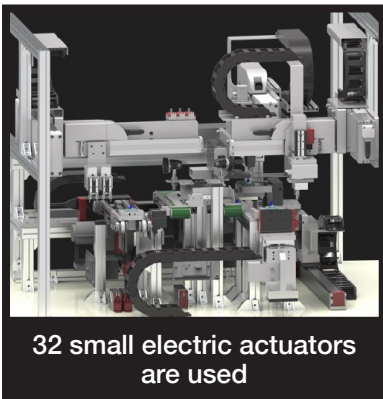

Workpiece cutting

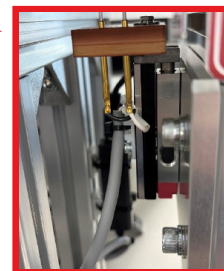

Lifting equipment

While fully electric systems were previously difficult to implement due to size constraints, they can now be implemented using micro cylinders.

Wireless connection is possible



It enables easy adjustments of devices that are installed remotely.



Instruction manual available!



Refer to the instruction manual for product specifications.
intelligentactuator.com/micro-cylinder

The Product catalog is coming soon



IAI America, Inc.

USA Headquarters & Western Region (Los Angeles): 2690 W. 237th Street, Torrance, CA 90505 (310) 891-6015
Midwest Branch Office (Chicago): 110 East State Parkway, Schaumburg, IL 60173 (847) 908-1400
Southeast Branch Office (Atlanta): 1220 Kennestone Circle, Suite 108, Marietta, GA 30066 (678) 354-9470

www.intelligentactuator.com

IAI Group Headquarters and Main Factory:

1210 Iharacho, Shimizu-ku, Shizuoka-shi, Shizuoka, 424-0114, JAPAN

The information contained in this product brochure may change without prior notice due to product improvements.

IAI Industrieroboter GmbH

Ober der Röth 4,
D-65824 Schwalbach am Taunus, Germany

IAI Robot (Thailand) Co., Ltd.

825 Phairokijja Tower 7th Floor, Debaratana Rd.,
Bangna Nuea, Bangna, Bangkok 10260, Thailand

IAI (Shanghai) Co., Ltd.

SHANGHAI JIAHUA BUSINESS CENTER A8-303,
808 Hongqiao Rd. Shanghai 200030, China